

Shinhoo®

GPA-II Series

**Energy-saving Pipeline Canned
Motor Pump**

**Installation and
Operation Manual**



CE RoHS

Anhui Shinhoo Canned Motor Pump Co., Ltd.

Notes:

01. Read the installation manual carefully before installation and use.
02. The manufacturer will not be liable for any personal injury, pump damage and other property damage due to failure to comply with contents specified in safety warning signs.
03. The installers and operators must comply with local safety regulations.
04. The user must confirm that only qualified personnel with professional certification and proficiency of this manual is allowed to install and maintain this product.
05. The pump must not be installed in a place that is damp or may be splashed by water.
06. For convenient access of maintenance, a shut-off valve shall be installed on each side of the pump
07. The power supply of the pump shall be cut off before installation and maintenance.
08. For domestic hot water, copper or stainless steel pump body shall be used.
09. Heat supply pipelines shall not be frequently filled with non-softened water so as to avoid increasing calcium in the circulating water inside the pipeline, which may thus block the impeller.
10. Do not start the pump without liquid.
11. Some models are not suitable for drinking water.
12. The liquid may be high-temperature and high-pressure; therefore, the liquid in the system must be completely drained or the shut-off valves on both sides must be closed before moving and dismantling the pump to prevent burning.
13. If removing the exhaust bolt, high-temperature and high-pressure liquid will be overflow. Therefore, it is necessary to insure that the outflow liquid will not cause personal injury or damage other parts.
14. Ventilation must be ensured in summer or high ambient temperature period to avoid condensation that may cause electrical malfunctions.
15. In winter, the pump system does not work or when the ambient temperature drops below 0°C , liquid in the system shall be completely drained so as to avoid frost cracking of pump body.
16. If the pump is left unused for a long time, please close the pipe valve in the inlet and outlet of the pump and cut off the power supply.
17. If the flexible cord of cable is damaged, it must be replaced by a qualified person.
18. Please close the valve at the inlet of the pump and cut off power of the pump immediately if overheating

and abnormality of motor is detected, and contact your vendor or service center immediately.

19. If trouble cannot be addressed according to the manual, please close the valves on the inlet and outlet of the pump immediately, cut off power supply and contact your vendor or service center immediately.
20. This product shall be put in a place out of reach of children. After installation, take an isolation measures to avoid access of children.
21. This product shall be stored in a dry, well ventilated and cool place under room temperature.



Warning

Before installation, you must carefully read the installation and operation manual. The installation and use of the equipment must comply with local regulation and applicable operation standards.



Warning

Those who have weak physical strength, react slowly or lack experience and knowledge (including children) can use this motor pump only under the monitoring and direction of his/her safety personnel.

1. Signs



Warning

Failure to comply with this safety instruction may lead to personal injury!

Caution

Failure to comply with this safety instruction may lead to equipment malfunction or damage!

Note

Note or instruction for easy and safe operations.

2. General

2.1. GPA series circulation motor pump is mainly used in domestic heating and hot water system.

The product is most applicable to the following systems:

- stable and variable-flow heat supply system
- variable-temperature pipeline heat supply system
- heat supply system with night mode
- PWM signal controlled system
- HVAC system
- industrial circulation system
- domestic heating and domestic water supply system

This pump is equipped with permanent-magnet motor and differential pressure controller, capable of automatically & continuously adjusting motor performance to meet the actual needs of system.

This pump is equipped with control panel on the front for easy operation by users.

2.2. Advantages

Easy installation and start-up

- Provided with self-adaptive mode AUTO

(Initial setting). In most cases, the motor pump needs no adjustment and can be readily started and automatically adjusted to meet the actual needs of the systems.

High-degree comfort

- Low operational noise of motor pump and whole system.

Low energy consumption

- Compared with traditional circulation motor pumps, it has lower energy consumption. GPA series circulation motor pump is attached with Europe Energy Label Class A marking, and the minimum energy consumption can reach up to 5W.

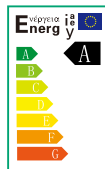
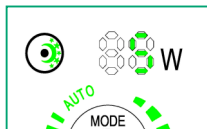

3. Operating Conditions

3.1. Ambient Temperature

Ambient temperature: 0 °C ~+ 40 °C

3.2. Relative humidity(RH):

Max. humidity: 95%

3.3. Medium (liquid delivery) temperature

Liquid delivery temperature: +2°C~110°C

To avoid condensation in control box and the stator, the temperature of liquid pumped by the motor pump must be always higher than ambient temperature.

3.4. System Pressure

Maximum pressure 1.0Mpa(10bar).

3.5. Degree of Protection

IP42

3.6. Inlet Pressure

Liquid Temperature	<85°C	90°C	110°C
Inlet Pressure	0.05bar	0.28bar	1bar
	0.5m head	2.8m head	10m head

3.7. Pumping Liquid

The pumping liquid includes thin, clean, non-corrosive and non-explosive liquid which shall not contain any solid particles, fiber or mineral oil, and the pump must definitely not be used to pump inflammable liquid such as rapeseed oil and gasoline. If the pump is used in a place with relatively high viscosity, the pump has lower performance. So when choosing a pump, the viscosity of liquid must be taken into account.

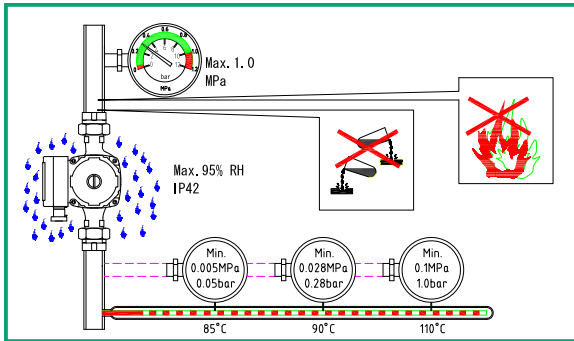

4. Installation

4.1. Installation

- When installing GPA series circulation pump, the arrow on motor pump case indicates the flow direction of liquid through the pump.
- When installing the motor pump in the pipeline, two supplied gaskets must be installed at the inlet and outlet.
- During the installation, the shaft of motor pump must be horizontal.

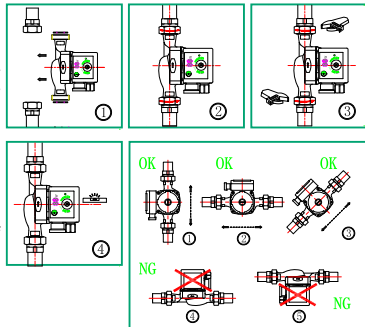

4.2. Position of Junction Box

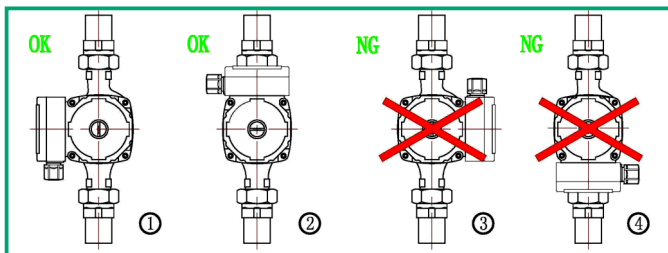

4.3. Changing Position of Junction Box

The junction box can be rotated in a step of 90° .

The procedures for changing the position of junction box are as follows:

1. Close the valves at the inlet and outlet and release the pressure;
2. Unscrew and remove the four socket head screws that fasten the pump body;
3. Rotate the motor to the expected position and align the four screw holes;
4. Install the four socket head screws again and fasten them clockwise;
5. Open the valves at the inlet and outlet.

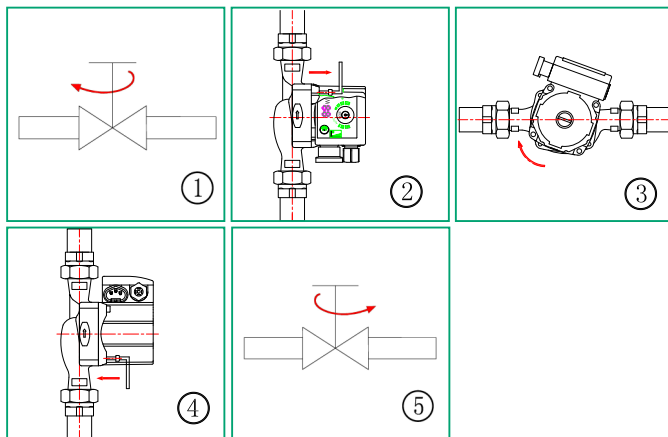



Warning

Pumping liquid may be high-temperature and high-pressure; therefore, the liquid in the system must be completely drained or the valves on both sides of motor pump must be closed before removing the socket head screws.

4.4. Thermal Insulation of Motor Pump Body

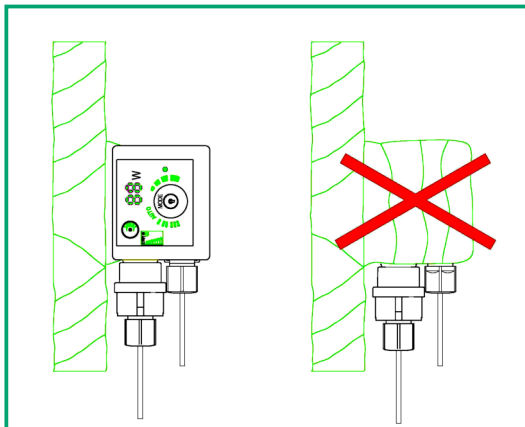

Note

Limiting the heat loss of motor pump body and pipeline.
Motor pump body and pipeline should be thermally insulated to reduce their heat loss.

Caution

Do not isolate or cover the junction box and control panel.

5. Electrical Connection

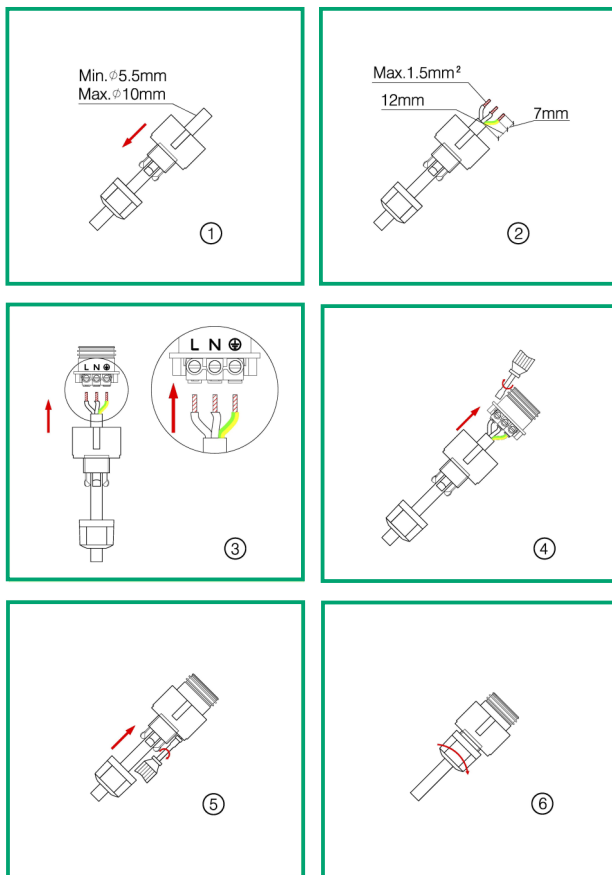

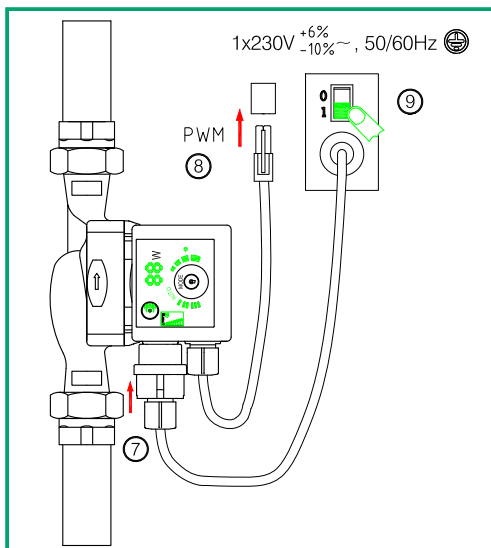

Electrical connection and protection shall comply with local codes and norms.



Warning

The motor pump must be earthed (⊕).

The motor pump must be connected to an external power switch, and the minimum space between all the electrodes is 3mm.

- GPA series circulation motor pump needs no protection from external motor.
- Check if the supply voltage and frequency are the same as parameters indicated on the nameplate of the motor pump.
- Connect the motor pump and power supply with the plug supplied together with the pump.
- After the power is supplied, the indicator lamp on the control panel is ON.

6. Control Panel

6.1. Controls on Control Panel

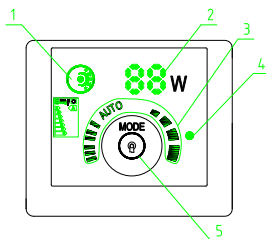

Position	Descriptions
1	Indication lamp area in the Night Mode (AUTO).
2	Button to start or turn off Night Mode (AUTO).
3	Monitor that displays the actual power consumption of motor pump in Watt.
4	Indication lamp area of eight operation modes set by motor pump.
5	Button for setting operation modes of the motor pump.

6.2. Indication lamp area of power consumption of motor pump

After the power is connected, the monitor in Position 2 works.

During operation, the indicated value is in Watt, showing the actual power consumption of the motor pump.

When the motor pump fails to work, the monitor indicates :

If malfunction is detected, the power supply must be cut off before troubleshooting. After the trouble is addressed, re-connect the power and start the motor pump.

Error Code	Description
E0	Over-voltage protection
E1	Under-voltage protection
E2	Over-current protection
E3	Under-load protection
E4	Missing phase protection
E5	Locked-rotor protection
E6	Motor start failure protection (Motor parameters do not match)

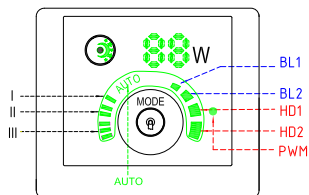

6.3. Indication Lamp Area of Motor Pump Setting

GPA-II series circulation motor pump has eight settings which can be chosen with the button.

The motor pump settings are indicated with eight different indication lamp areas and display is controlled by PWM external signal.

Button Times	Indication Lamp Area	Descriptions
0	AUTO (Initial setting)	Self-adaptive (AUTO)
1	BL1	Lowest Proportional Pressure Curve
2	BL2	Highest Proportional Pressure Curve
3	HD1	Lowest Constant Pressure Curve
4	HD2	Highest Constant Pressure Curve
5	III	Constant Velocity Curve, Velocity III
6	II	Constant Velocity Curve, Velocity II
7	I	Constant Velocity Curve, Velocity I
	PWM	Duty Cycle and Rotational Speed Curve (Controlled by external signal)

6.4. Button for selecting motor pump settings

By pressing the button once at 2 seconds interval, the motor pump setting mode will change once.

A cycle is constituted of every eight presses on the button. For details, please refer to Section 6.3.

6.5. Button to Display Night Mode and Start Night Mode

- When  is on, it indicates that the Night Mode is activated.
- Press this button to activate and deactivate Night Mode.
- Night Mode is only applicable to heating system equipped with this function.
- Initial setting: Night Mode not set

Note

If the pump has been set to Velocity I, Velocity II, Velocity III or PWM signal control, then Night Mode Function cannot be selected.

7. Pump Setting

7.1. Pump Setting Based on System Type

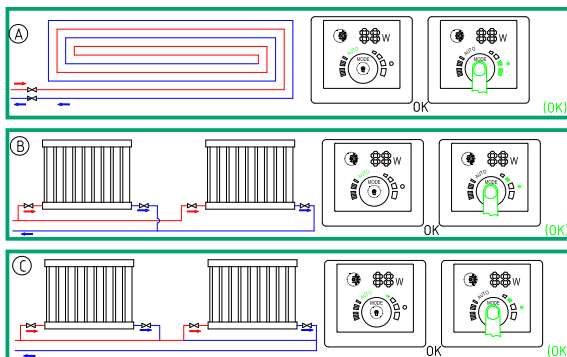

Initial setting= AUTO (Self-adaptive mode)

Recommended and available pump setting

Position	System Type	Motor Pump Setting	
		Recommended	Options
A	Floor heating system	AUTO	HD1、HD2、PWM
B	Dual pipeline heating system	AUTO	BL2、PWM
C	Single pipeline heating system	BL1	BL2、PWM

- AUTO (Self Adaptive Mode) mode can adjust the performance of motor pump based on the actual heat demand of the system. As the performance is adjusted gradually, it is suggested, before changing motor pump setting, to maintain AUTO (Automatically Adaptive Mode) mode setting for at least one week.
- If you select to change back to AUTO (Self Adaptive Mode) mode, the GPA series motor pump can memorize its last setting in AUTO mode and continue adjusting the performance automatically.

- It may take several minutes or even hours to reach the optimal operation mode after motor pump setting is changed from the optimal setting (the "Recommended above-mentioned") to other optional setting. If the optimal setting of motor pump fails to enable each room to obtain desired heat distribution, then you should change the motor pump setting to other settings.
- Please refer to Section 12.1 for the relations between pump setting and performance curve.

7.2. Control Pump

When the pump is working, the pump is controlled according to the principle of "Proportional Pressure Control (BL)" or "Constant Pressure Control (HD)"

In these two control modes, the pump performance and corresponding power consumption will be regulated according to the heat demand of the system.

Proportional Pressure Control

In this control mode, the differential pressure of both ends of the pump will be controlled by the flow rate. In the Q/H Figure, proportional pressure curve is represented with BL1 and BL2. Please refer to Section 12.1.

In these two control modes, the pump performance and corresponding power consumption will be regulated according to the heat demand of the system.

Constant Pressure Control

In this control mode, the differential pressure of both ends of the pump remains constant and is irrelevant to the flow rate. In the Q/H Figure, constant pressure curve is a horizontal performance curve represented with HD1 and HD2. Please refer to Section 12.1.

8. Night Mode (AUTO)

8.1. Basic Principle

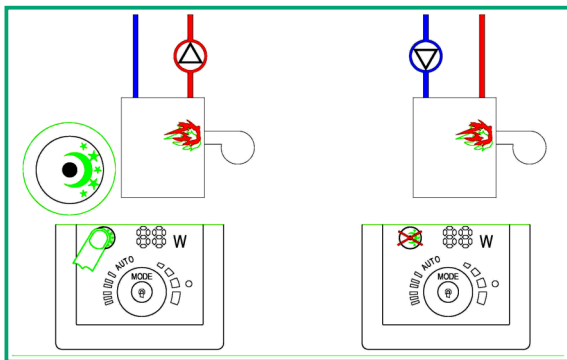

Warning

Night Mode is unavailable for the GPA series motor pump installed in gas boiler heating system with small water capacity.

Note

If Velocity I , Velocity II , or Velocity III mode have been selected, the Night Mode will be disabled; if PWM mode signal input is selected, then functions of other modes will be disabled.

Note

If power supply once has been cut off, then the Night Mode shall be restarted.

Note

If heat supply of the heating system is insufficient (not enough heat), then check if the Night Mode function is activated. If yes, disable the Night Mode function.

To ensure that the best status is realized in Night Mod, the following conditions must be satisfied:

- The motor pump must be installed in the water inlet pipeline of the system and near the water outlet of boiler.
- If the motor pump is installed in the water return pipeline of the system, then the Night Mode function will be disabled.
- The system must be included with liquid temperature automatic control.
- Press  button to activate night mode.
- Please refer to Section 6.5.

8.2. Night Mode Function

Once the Night Mode is enabled, GPA series motor pump will automatically switch between normal mode and Night Mode.

The switching of GPA series motor pump between normal mode and Night Mode depends on the temperature of system inlet pipeline (not water return pipeline).

When the temperature drop of system inlet pipeline within two hours is higher than 10~15℃, GPA series motor pump will switch to Night Mode automatically. The temperature drop must be at least 0.1℃/min.

when the temperature of system pipeline rises about 10℃, it will switch to normal mode (time irrelevant).

9. PWM Signal Control Mode

9.1. Control and Signal Mode

1) Control Principle

GPAXX-XX II model pump is controlled by modulated LV PWM (Pulse Width Modulation) digital signal, which means that the variance of velocity depends on the external input signal. The variance of velocity is one of the functions of input control.

2) Digital LV PWM (Pulse Width Modulation) Signal

Design frequency scope of square wave PWM signal: 40Hz-4000Hz;

PWM input signal (PWM IN) is used to give velocity commands, and adjusts the velocity commands through adjusting PWM duty cycle.

PWM output signal (PWM OUT) is the feedback signal of the pump, and the PWM frequency is fixed at 75Hz.

3) Duty Cycle d%

$$T = 2 \text{ ms} \quad 500\text{Hz}$$

$$t = 0.6 \text{ ms}$$

$$d\% = 100 \times 0.6 / 2 = 30\%$$

$$U_{IH} = 4 \sim 24\text{V}$$

$$U_{IL} \leq 1\text{V}$$

$$I_{IH} \leq 10\text{mA}$$

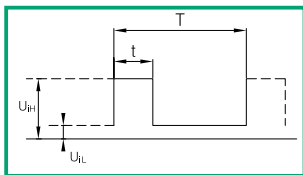

Code	Descriptions
T	Cycle
d	Duty Cycle
U_{IH}	Input High Voltage
U_{IL}	Input Low Voltage
I_{IH}	Input Current

9.2. Interface

The pump is controlled by external electrical elements and components through interfaces. The interfaces convert external signals into signals that can be recognized by microprocessor in the pump. In addition, when the pump is supplied with 230V voltage, the interfaces can ensure that users will not be at risk of high voltage electric shock when contacting the signal cable.

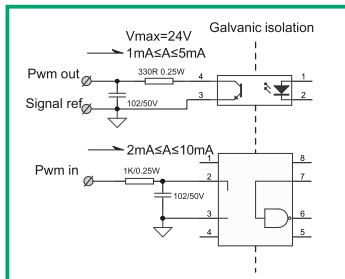

Note

"Signal Ref" is a reference earthing, and it is not connected to protective earthing.

9.3. PWM Input Signal

9.3.1 PWM input signal profile PWM1 (heating)

- In area of high duty-cycle PWM1 signal, when the input signal fluctuates in the critical point, there will be a delay area to prevent frequent stop and start of the pump.
- When PWM1 input signal is 0% or 100%, the pump will switch to non-PWM mode (normal mode), and the default system will have no PWM signal input.
- In area of low duty-cycle PWM1 signal, the pump runs at high velocity for the sake of system safety. For instance, when the signal cable of gas boiler system is damaged, the pump will continue to run at the maximum rotational speed and transfer heat through main heat exchanger. This is also applicable to heat pump, ensuring continuous heat transfer in the case of signal cable of pump is damaged and system safety is guaranteed.

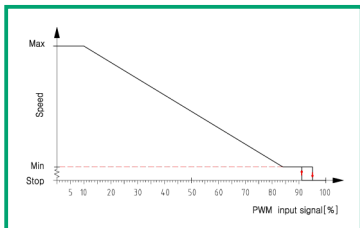

PWM1 Input Signal (%)	Pump Status
0	the pump switches to non-PWM mode (normal mode), and the default system will have no PWM signal input.
< 10	the pump runs at the highest velocity
10 ~ 84	the pump curve will drop from the highest to the lowest
85 ~ 91	the pump runs at the lowest velocity
91 ~ 95	if the velocity variance point of input signal fluctuates, then it will block the start and stop of the pump according to the principle of magnetic hysteresis
96 ~ 99	stand-by, the pump stops
100	the pump switches to non-PWM mode (normal mode), and the default system will have no PWM signal input.

Note

This system is adaptive to the automatic switching of PWM1 and non-PWM mode. When there is PWM1 signal input, the system will enter PWM1 mode.

9.3.2 PWM input signal profile PWM2(solar)

- In area of low duty-cycle PWM2 signal, when the input signal fluctuates in the critical point, there will be a delay area to prevent frequent stop and start of the pump.
- Without PWM2 signal percentages, the circulator will stop for safety reasons. If a signal is missing, for example due to a cable breakage, the circulator will stop to avoid overheating of the solar thermal system.
- When PWM2 input signal is 0 or 100%, the pump will switch to non-PWM mode (normal mode), and the default system will have no PWM signal input.

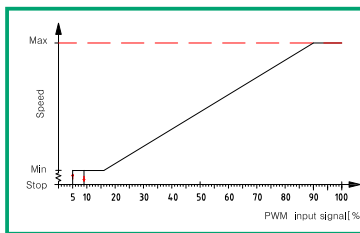

PWM2 Input Signal(%)	Pump Status
1~4	Stand-by,the pump stops.
5~7	if the velocity variance point of input signal fluctuates, then it will block the start and stop of the pump according to the principle of magnetic hysteresis.
8~16	The pump runs at the lowest velocity
17~90	The pump curve will rise from the lowest to the highest.
91~99	The pump runs at the highest velocity.
100	The pump switches to non-PWM mode(normalmode), and the default system will have no PWM signal input.

9.4. PWM Feedback Signal

PWM feedback signal can provide operation status of the pump, such as power loss or all kinds of alarm/warning modes.

PWM feedback signal will feed back exclusive alarming information. If the power voltage detects under voltage signal values, its output signal will be set to 75%. Provided sundries settlement exists in the hydraulic system and causes rotor being blocked, the duty cycle of output signal is set to 90%, the alarm will be given higher priority.

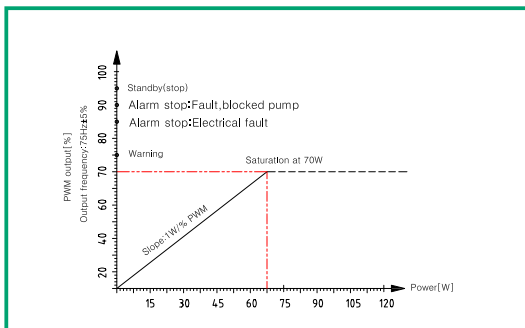

PWM Output Signal (%)	Pump Status	Descriptions
95	Standby (stop)	the pump stops
90	alarm stops, malfunctions (pump blocked)	the pump does not work and will restarts only after trouble is addressed
85	alarm stops, electrical malfunction/trouble	the pump does not work and will restarts only after trouble is addressed
75	warning	the pump runs, trouble has been detected under this situation but it is not critical, and the pump can still work.
0 ~ 70	0-70W(slope 1 W/% PWM)	

9.5. How to use the signals

The signal can be used to measure power consumption of the pump. The pump signal can be used to detect the actual operating point of the system rather than measuring by the current controlled by the system. The signal is also applicable to comparing velocity setting value and feedback.

For example:

A boiler controlled system gives a PWM signal setting GPA25-6 II 03 to 41%, see Figure A.

If control system detects 40% of PWM signal in the feedback signal at the same time, then the flow rate will be about $1.4\text{m}^3/\text{h}$ and corresponding head of delivery is 2.6m , see Figure B.

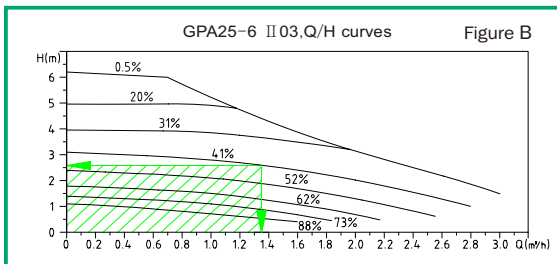
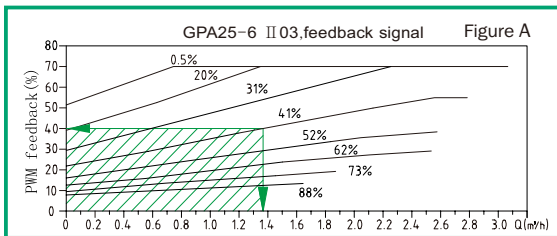

10. Bypass valve system installed between the Inlet pipeline and return pipeline

10.1. Purposes of bypass valve

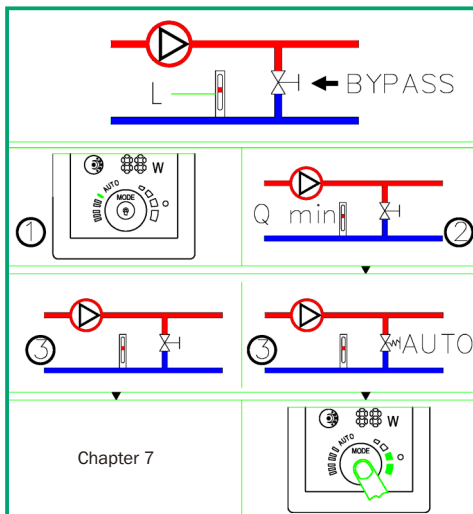

Bypass valve

The purpose of bypass valve: when all the valves and/or temperature-sensing valves of heat radiator in the floor heating loop are closed, it can ensure that the heat from boiler can be distributed.

Elements in the system:

- bypass valve
- flow meter, position L.

When all valves are closed, the minimum flow rate must be guaranteed.

The setting of pump position depends on the type of bypass valve, i.e. manual bypass valve or temperature-sensing bypass valve.

10.2. Manually-operated Bypass Valve

In accordance with the following procedures:

1. When regulating bypass valve, the pump shall be in Setting I (Velocity I Mode).
The minimum flow rate (Q_{\min}) of the system shall be always guaranteed. Please refer to bypass valve manual provided by the manufacturer.
2. After the regulating of bypass valve completes, set the pump in accordance with Section 12.1 of Pump Setting.

10.3. Automatic Bypass Valve (temperature-sensing type)

Follow the following procedures:

1. When regulating bypass valve, the pump shall be in Setting I (Velocity I Mode).
The minimum flow rate (Q_{\min}) of the system shall be always guaranteed. Please refer to bypass valve manual provided by the manufacturer.
2. After the regulating of bypass valve completes, set the pump to lowest or highest constant pressure mode. For the relations between pump setting and performance curve, please refer to Section 12.1 of Pump Setting and Pump Performance.

11. Start up

11.1. Before Start Up

Before starting the motor pump, ensure that the system is filled with liquid, air has been completely exhausted, and the inlet of motor pump must reach minimum inlet pressure. Please refer to Chapter 3.

11.2. Exhaust the Motor Pump

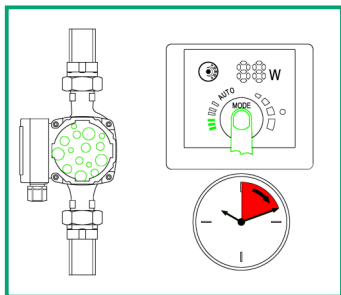

Caution Motor pump cannot run in idle speed without pumping liquid.

GPA series motor pump is equipped with self-venting function. Before the start up, it is not necessary to vent the air. Air in the motor pump may cause noise. After the motor pump is put into operation for several minutes, the noise will disappear.

Based on the system scale and structure, set the GPA series motor pump to VelocityIII for a short period of time and air in the pump can be quickly vented.

After air is vented from the motor pump and noise disappear, set the motor pump in accordance with the manual. Please refer to Chapter 7.

11.3. Vent the heating system

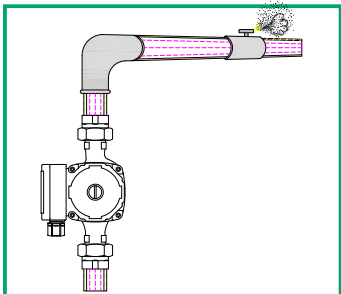

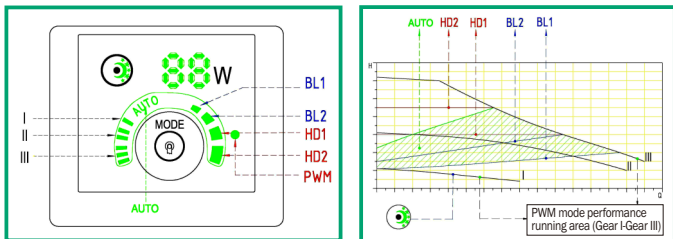

12. Motor Pump Setting and Performance

12.1. Relations between Pump Setting and Performance



Setting	Pump Characteristics Curve	Functions
AUTO (Initial Setting)	Highest to Lowest Proportional Pressure Curve	AUTO function will automatically control the pump performance within the specified scope. adjust pump performance based on system scale; adjust pump performance based on load variance within a period of time; Under the AUTO mode, the pump will be set to proportional pressure control;
BL1	Lowest Proportional Pressure Curve	The operating point of the pump will move up and down on the lowest proportional pressure curve based on the demand of system flow rate. When flow demand decreases, the pressure supply of pump drops; when flow demand increases, the pressure supply of pump rises.
BL2	Highest Proportional Pressure Curve	The operating point of the pump will move up and down on the highest proportional pressure curve based on the demand of system flow rate. When flow demand decreases, the pressure supply of pump drops; when flow demand increases, the pressure supply of pump rises.

Setting	Pump Characteristics Curve	Functions
HD1	Lowest Constant Pressure Curve	The operating point of the pump will move around the lowest constant pressure curve based on the demand of system flow rate. The supply pressure of pump remains constant and it is irrelevant with the flow rate.
HD2	Highest Constant Pressure Curve	The operating point of the pump will move around the highest constant pressure curve based on the demand of system flow rate. The supply pressure of pump remains constant and it is irrelevant with the flow rate.
III	Velocity III	It runs on the constant curve in a constant velocity. In the Velocity III mode, the pump is set to work on the highest curve under all working conditions. Setting the pump as Velocity III mode within short period of time can quickly vent the pump.
II	Velocity II	It runs on the constant curve in a constant velocity. In the Velocity II mode, the pump is set to work on the intermediate curve under all working conditions.
I	Velocity I	It runs on the constant curve in a constant velocity. In the Velocity I mode, the pump is set to work on the lowest curve under all working conditions.
		As long as certain conditions are met, it will switch to Automatic Night Mode and run in the lowest performance and power.
PWM	Duty cycle and rotational velocity curve	The rotational velocity of pump can be adjusted based on PWM (duty cycle). When the duty cycle is 0% or 100%, the PWM mode is disabled and the pump will automatically switch the previous mode. PWM mode supports velocity adjustment, and under abnormal rotational velocity such as pump blocking or running in low voltage, it will generate feedback signal.

13. Performance Curve

13.1. Guide on Performance Curve

Every setting of the motor pump has corresponding performance curve (Q/H curve). However AUTO (Self Adaptive Mode) mode covers just one performance scope.

The area of PWM signal control performance curve (Q/H curve) is between motor pump velocity I-III. The input power curve (P1 curve) belongs to every Q/H curve. Power curve represents the power consumption of motor pump in given Q/H curve with Watt as the unit.

P1 value corresponds to the readings taken from the monitor of motor pump.

13.2. Curve conditions

The followings are applicable to the performance curve specified in the GPA series manual:

- Test liquid: air-free water.
- Applicable density of curve $\rho=983.2 \text{ kg/m}^3$, and liquid temperature $+60^\circ\text{C}$.
- All curves represent averaged value, and shall not be used as guarantee curve. If a specific performance is needed, then separate measuring shall be conducted.
- Velocity I, II, III curves have all been marked.
- The applicable Kinetic viscosity of the curve $\nu=0.474 \text{ mm}^2/\text{s}$ 0.474CcST

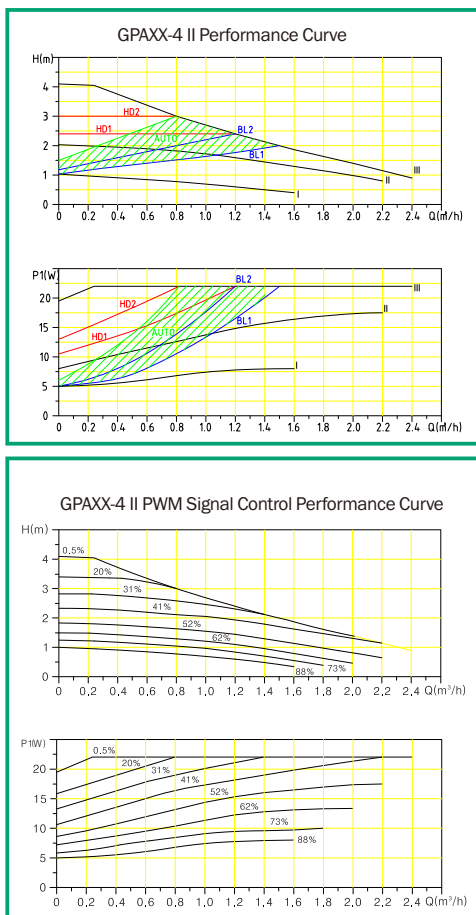
13.3. GPA \times -4 II Series Performance Curve

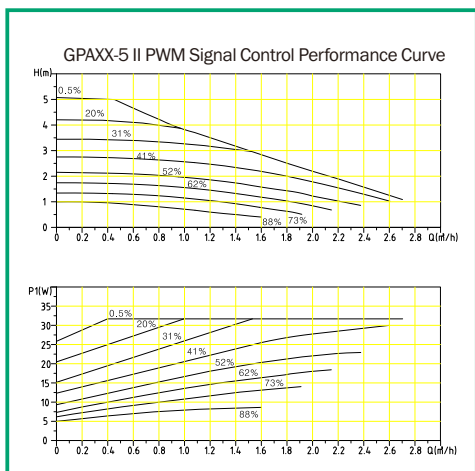
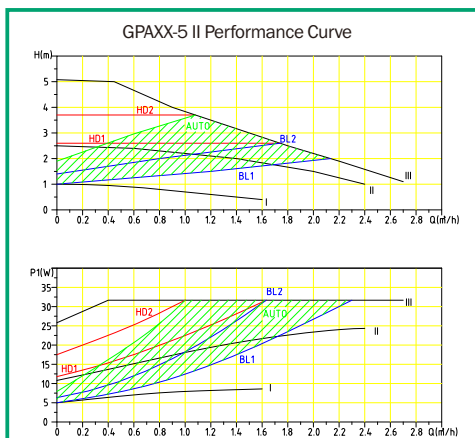
13.4. GPA \times \times -5 II Series Performance Curve

13.5. GPA××-6 II Series Performance Curve

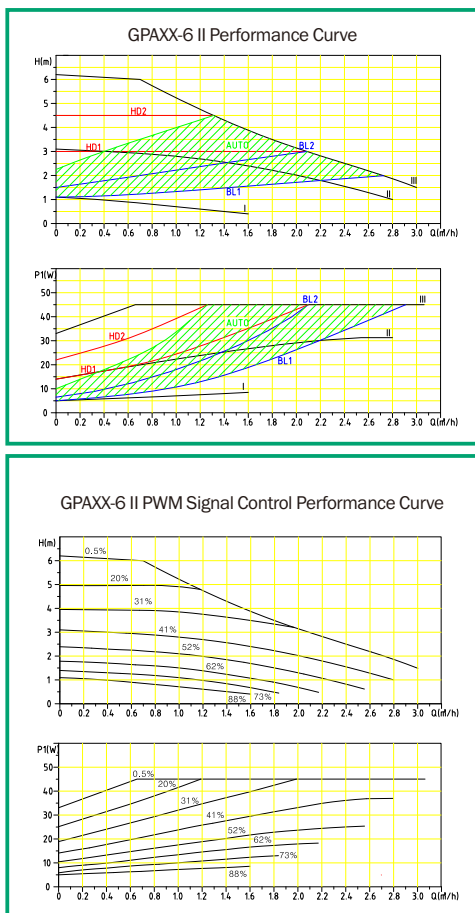

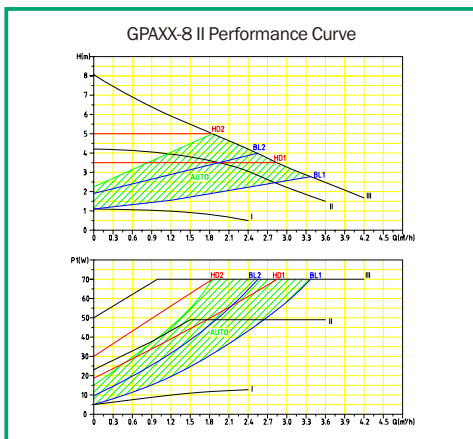
13.6. GPA $\times\times$ -8 II Series Performance Curve

GPAXX-8 II PWM Signal Control Performance Curve

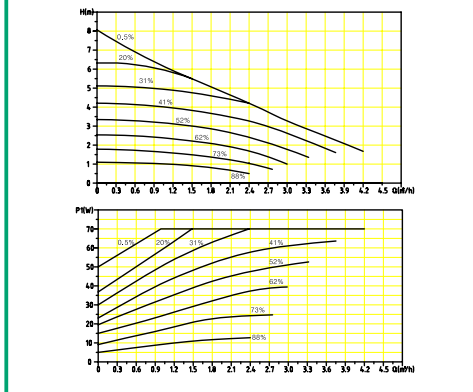

14. Features

14.1. Nameplate Instructions

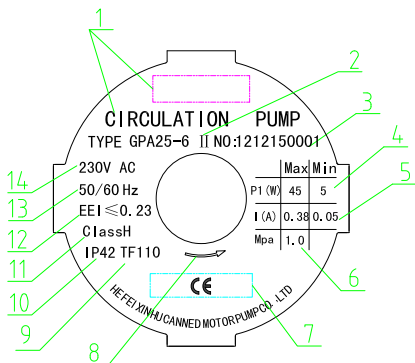

No.	Descriptions	
1	Manufacturer Name	
2	Product Model	
3	Product	Digit 1 to digit 6 indicates manufacturing date
	No.	Digit 7 to digit 10 indicates serial number
4	Power (Watt)	Minimum input power P1
		Maximum input power P1
5	Current (Amp)	Minimum current
		Maximum current
6	Maximum system load bearing (Mpa)	
7	Authentication mark	
8	Direction of rotation	
9	Temperature class	
10	Degree of protection	
11	Insulation class	
12	Energy Index	
13	Frequency (Hz)	
14	Voltage (v)	

14.2. Model Instructions

The model of motor pump is composed of capitalized Latin letters and Arabic numbers, which means:

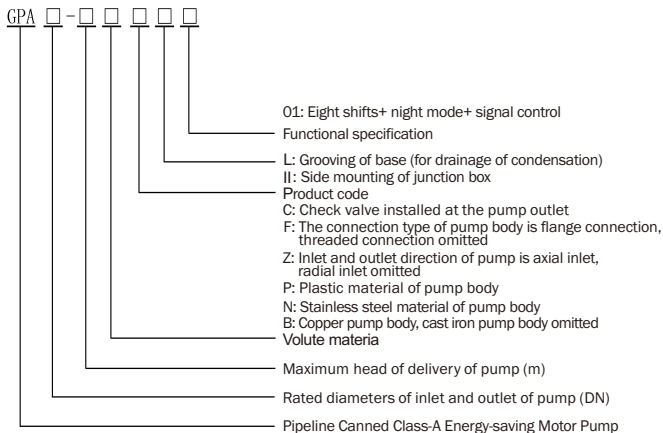

Model Example: GPA25-6B II01 means the inlet and outlet diameter of pump is DN25, maximum head is 6m, side mounting of junction box of pump body, and the functions are Eight shifts+ night mode+ signal control.

15. Technical Parameters and Installation Dimensions

15.1. Technical Parameters

Power Supply Voltage	1×230V +6%/-10%,50/60Hz,PE	
Motor Protection	The pump needs no external protection	
Degree of Protection	IP42	
Insulation Class	H	
Relative Humidity (RH)	Max. 95%	
System Load Bearing	1.0 MPa	
Suction Port Pressure	Liquid Temperature	Minimum Inlet Pressure
	≤+ 85℃	0.005 MPa
	≤+ 90℃	0.028 MPa
	≤+ 110℃	0.100 MPa
EMC Standard	EN61000-3-2 and EN61000-3-3	EN55014-1 and EN55014-2
Sound Pressure Class	The sound pressure level of pump is lower than 43dB(A)	
Ambient Temperature	0~+ 40℃	
Temperature Grade	TF110	
Surface Temperature	The maximum surface temperature is not higher than +125℃	
Liquid Temperature	+ 2~+ 110℃	

To prevent condensation in the junction box and rotor, the temperature of pumping liquid of the motor pump must be always higher than ambient temperature.

Ambient Temperature (°C)	Liquid Temperature	
	Min. (°C)	Max. (°C)
0	2	110
10	10	110
20	20	110
30	30	110
35	35	90
40	40	70

For domestic hot water, it is suggested that water temperature should remains below 65℃ to reduce scaling.

15.2. Installation Dimensions

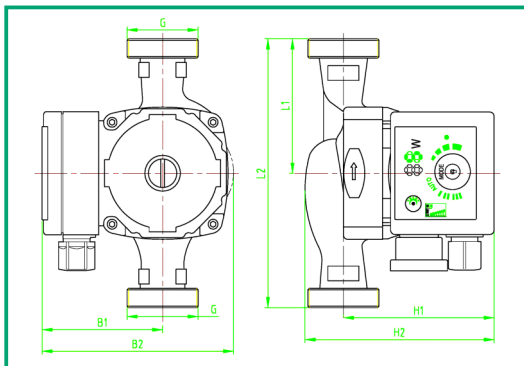

Power (W)	Product Model	Material of Pump Body				Dimension (mm)						
		Cast Iron	Plastic	Copper	SS	L1	L2	B1	B2	H1	H2	G
22	GPA20-4P II		●			65	130	82	128	103	130	1"
	GPA20-4 II	●		●	●	65/75	130/150	82	130	103	127	
	GPA25-4 II	●		●	●	65/75/90	130/150/180	82	130	103	130	1½"
	GPA32-4 II	●				90	180	82	130	102	132	2"
32	GPA20-5P II		●			65	130	82	128	103	130	1"
	GPA20-5 II	●		●	●	65/75	130/150	82	130	103	127	
	GPA25-5 II	●		●	●	65/75/90	130/150/180	82	130	103	130	1½"
	GPA32-5 II	●				90	180	82	130	102	132	2"
45	GPA20-6P II		●			65	130	82	128	103	130	1"
	GPA20-6 II	●		●	●	65	130	82	130	103	127	
	GPA25-6 II	●		●	●	65/75/90	130/150/180	82	130	103	130	1½"
	GPA32-6 II	●				90	180	82	130	102	132	2"
70	GPA20-8P II		●			65	130	88	136	103	130	1"
	GPA20-8 II	●		●	●	65	130	88	136	103	127	
	GPA25-8 II	●		●	●	65/75/90	130/150/180	88	136	103	130	1½"
	GPA32-8 II	●				90	180	88	136	102	132	2"

16. Trouble-Shooting Schedule



Warning

Before conducting any maintenance and repair of the motor pump, ensure that power supply has been cut off and will not be connected accidentally.

Symptom	Control Panel	Cause	Corrective Action
Motor pump cannot be started	Indication lamp "Off"	Equipment fuse burned	Replace the fuse
		The circuit breaker of current control or voltage control opens	Connect the circuit breaker
		Failure of motor pump	Return to factory maintenance
	E0	High voltage	Check whether power supply is in specified range
	E1	Under voltage	Check whether power supply is in specified range
	E2	PCB component failure or motor failure	Return to factory maintenance
	E3	No water in the pump	Open the valve and supply water to the pump
	E4	Missing phase protection	Return to factory maintenance
	E5	Rotor blocked	Remove the pump housing and clean the rotor
E6	Motor resistance parameters do not match	Return to factory maintenance	
Noise in the system	Indicating one value	Air exists in the system	Vent the system
		Excessively high flow rate	Lower inlet pressure of the motor pump
Noise in the motor pump	Indicating one value	Air exists in the motor pump	Vent the system
		Excessively low inlet pressure	Increase inlet pressure
Insufficient heat	Indicating one value	Poor performance of motor pump	Increase inlet pressure of motor pump

Product Warranty

Anhui Shinhoo Canned Motor Pump Co. , Ltd. offers 12 months of quality warranty for its products since the date of sales, and is responsible for product malfunctions or damaged due to manufacturing and material defects. This warranty is valid only when the product is installed strictly in accordance with Xihu installation and operation manual and certified operation practices.

This warranty is not applicable to product malfunctions or damage due to ① use in any other purpose other than that recommended by Xihu company; ② failure of compliance with Xihu installation and operation manual in the use of product; ③ inappropriate repair or moving of the product; ④ dismantling the product and/or replacing parts by themselves.

Any product supplied but not manufactured by Hefei Xihu Canned Motor Pump Co., Ltd shall comply with the quality warranty terms and conditions specified by its manufacturer.

During the warranty period, the user can have the product repaired with purchase invoice and warranty card. Please deliver or send the product to your vendor or designated repair center of Anhui Shinhoo Canned Motor Pump Co. , Ltd. for repair. Hefei Xihu Canned Motor Pump Co., Ltd can decide whether to offer free home repair according to the local repair policies. The repair of parts and components within warranty period is free of charges.

Anhui Shinhoo Canned Motor Pump Co. , Ltd. does not accept claims for damages due to third party liability or malfunctions caused by products of other companies.

Anhui Shinhoo Canned Motor Pump Co. , Ltd. will not be liable for product malfunctions or damage due to abnormal operation conditions, war, riot, wind (rain) storm, disaster or other force majeure.

Anhui Shinhoo Canned Motor Pump Co. , Ltd. reserves the right to interpret any matters unmentioned in this product warranty.